



OMEGA

**LONGITUDINAL
CUTTING**

OMEGA

LONGITUDINAL CUTTING

LONGITUDINAL CUTTING INSTALLATION FOR HOME TEXTILE.

Centring of the fabric, detection devices and sensors to control the cut, cutting section, plaiting. The longitudinal cutting machine **OMEGA** can successfully complete all lengthwise cutting processing procedures with an incredibly high level of quality and productivity.

Since 1975 we have increasingly deepened, through a constant and accurate system of research and development, how to get high quality in the process of the longitudinal cutting without compromising efficiency, productivity and flexibility.

And so born **OMEGA**, the latest generation of longitudinal cutting machine, which combines the use of the most advanced technologies with maximum usability.

State of the art in achieving the greatest goal: customer's satisfaction.

EFFICIENCY AND PRODUCTIVITY

The speed in cutting as well as a technology based on intelligent control systems, grant an unprecedented productivity and efficiency in the working process, with the main aim to get an attractive cost-performance ratio.

CUT QUALITY AND PRECISION

Innovation and research allowed to further increase the quality and precision of the longitudinal cut optimizing the workflow and granting a continuous cycle working process 24/7.

FLEXIBILITY

Different detecting systems allow cutting the cloth by following a printed colored line, metallic thread, warp picks absence, prefixed size and pile detection. This grants an high flexibility level, which is an indispensable condition in the current competitive market.



CUSTOMIZE AS PER YOUR REQUIREMENTS

Detection options

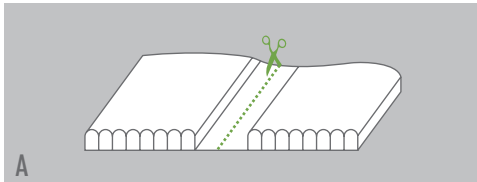

A Pile sensing

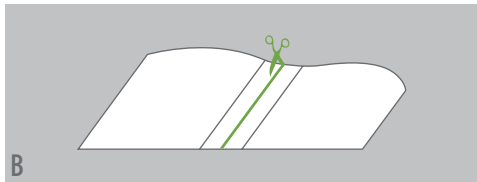

B Colored line

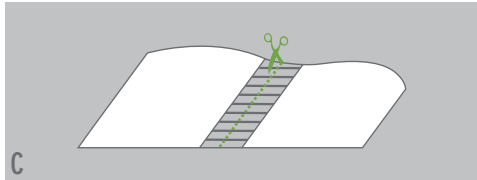

C Warp absence

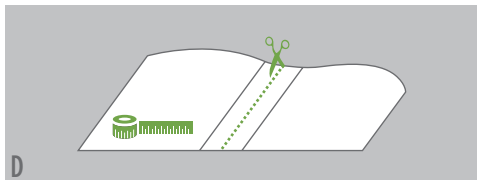

D Pre-fixed size

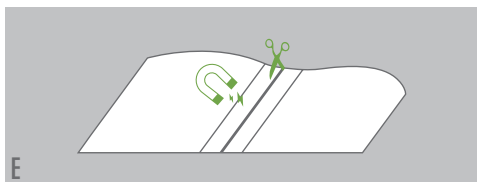

E Metal thread

Cutting options

- Circular blade
- Zig-Zag circular blade
- Blade and counter-blade

Cutting heads

Number of cutting heads depending on customer's.

Range of home textiles

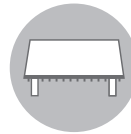

TABLE LINEN

Tablecloths
Napkins
Dishtowels
Kitchen Towels
Table Runners
Tea Towels



BED LINEN

Pillow cases
Pillow ticks
Cushions

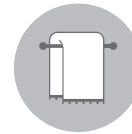

TERRY TOWELS



CLEANING CLOTHS



CURTAINS



MUCH MORE

Remote assistance

The latest technology capable to ensure the best technical support from off site, on-line monitoring and remote diagnostics.





**MAGETRON
IS GREEN**

We are 100% Solar Energy.
Our Environment & Social
Responsibility Commitment.



MAGETRON
textile innovation



Via Provinciale, 111 • 40053 Valsamoggia
Loc. Crespellano (BO) • ITALY
T +39 051 969211 • F +39 051 969335
sales@magetron.com • www.magetron.com

OVERALL DIMENSIONS

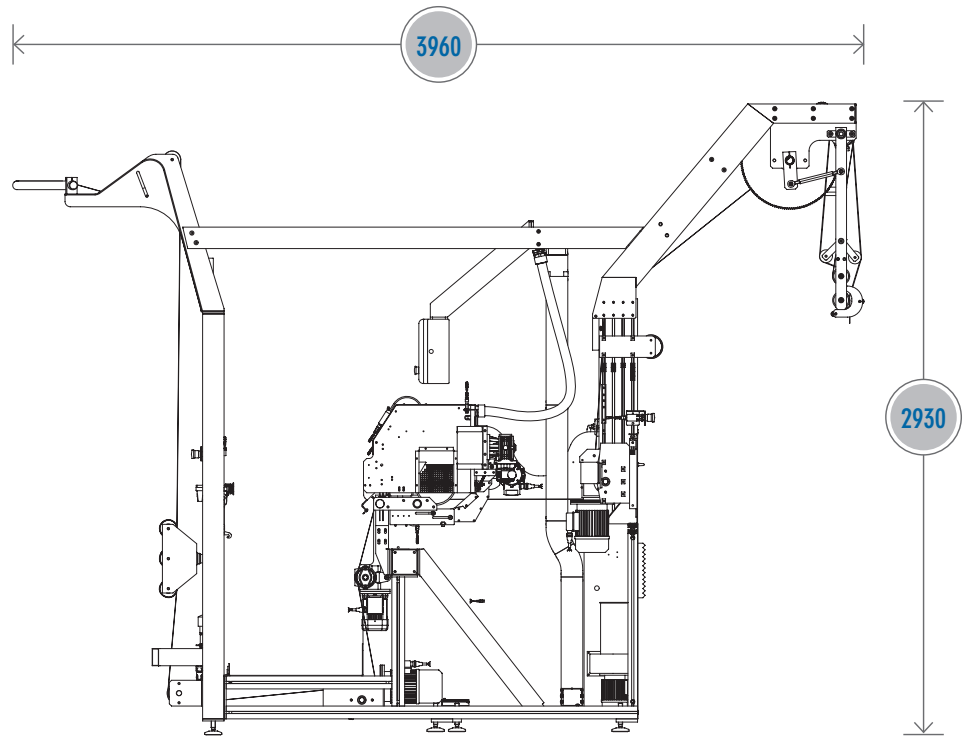

WIDTH OPTIONS

A	B
2500	3006
3500	4006

A - Product Width
B - Machine Width

